



# **Pyroelectric Infrared Radial Sensor**

Type:D205B

**Eagle Power International Holdings Ltd.**

**General Purpose and Omni-directional Quad Element  
Pyroelectric Infrared Radial Sensor**

The pyroelectric infrared sensor detects infrared radiation on the basis of the characteristics that the self-polarization of pyroelectric material changes with temperature. Quad sensing elements are applied to suppress the interference resulting from circumstance temperature variation, to raise signal output and to be sensitive in all directions. This type sensor has the technical merits of both single and dual type. As a result, the operating stability of the sensor is greatly improved. It can be widely used in many applications such as in automatic light switch control, security systems, burglar alarms, visitor acknowledgement and intellectualized toy, etc., especially in the field of ceiling mount applications.

■ Standard Specifications and Dimensions

Recommended Model	D205B
Encapsulation Type	TO-5
IR Receiving Electrode	0.7×2.4mm, 4elements
Window Size	4.9×4.9mm
Spectral Response	5—14μm
Transmittance	≥75%
Output Signal[Vp-p]	≥5000mV
Sensitivity	≥4300V/W
Detectivity (D*)	$1.6 \times 10^8 \text{ cmHz}^{1/2}/\text{W}$
Noise[Vp-p]	<70mV
Output Balance	<10%
Offset Voltage	0.3~1.2V
Supply Voltage	3—15V
Operating Temp	-30—70°C
Storage Temp	-40—80°C

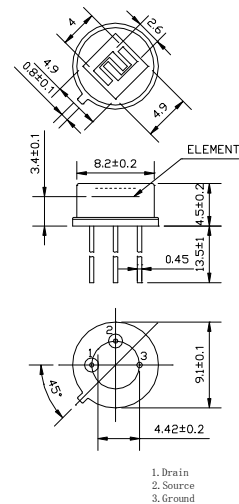

Field of View

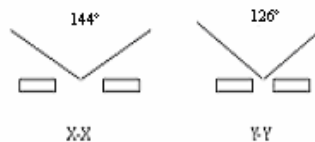

Equivalent Circuit

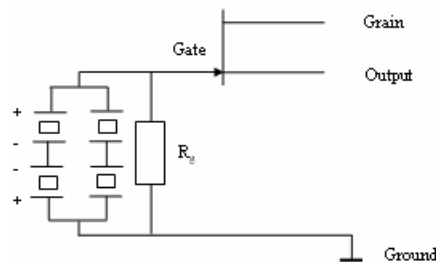

■ Test Method

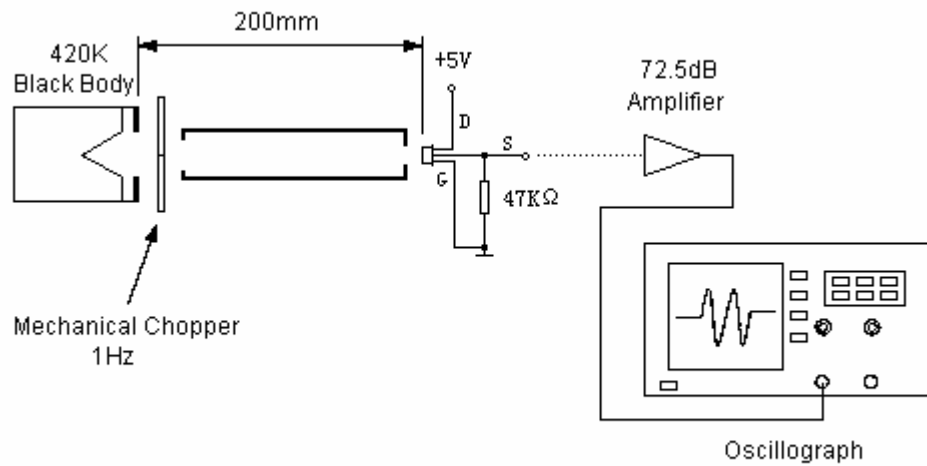

#### Measurement conditions

- ◆ Circumstance situation temperature 25°C
- ◆ Black-body temperature 420K (@147°C)
- ◆ Chopping frequency 1 Hz, 0.3~3.5Hz  $\Delta f$ ,
- ◆ 72.5 dB Amplifier

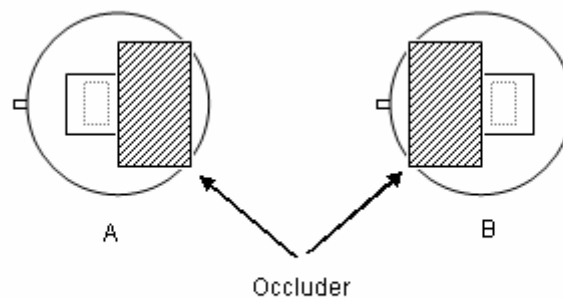

The sensitivity balance of dual elements sensor is calculated by measuring the sensitivity (signal output voltage) of each element and uses the formula as below:

$$\text{Balance} = \frac{|V_A - V_B|}{(V_A + V_B)} \times 100\%$$

$V_A$  = Sensitivity of side A ( mVp-p )

$V_B$  = Sensitivity of side B ( mVp-p )

#### ■ Typical Application

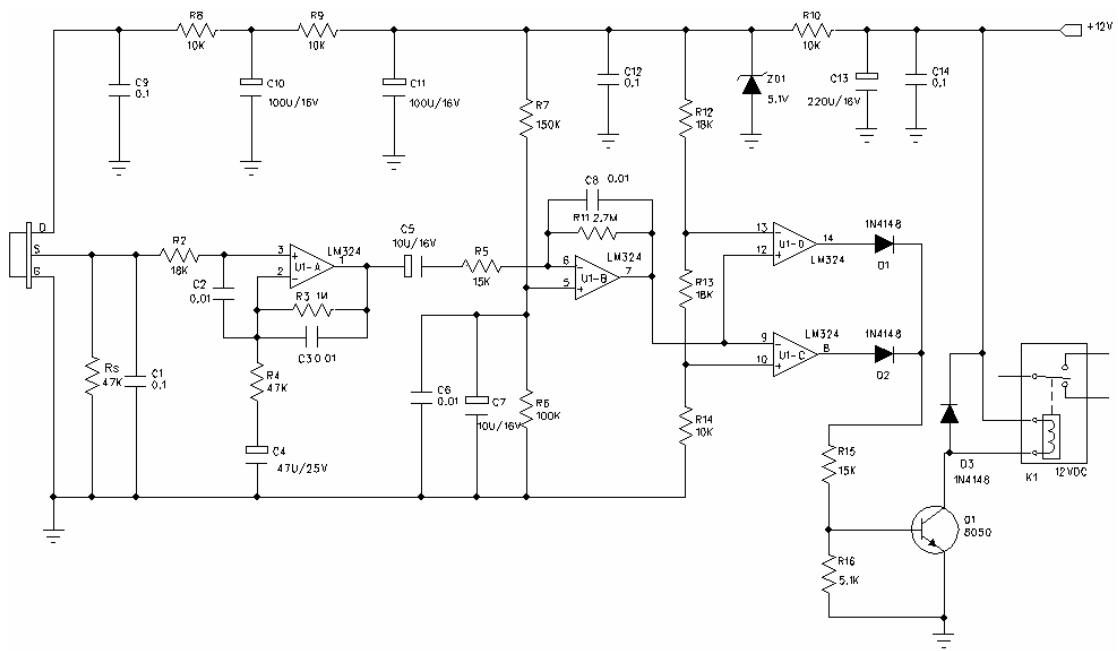

Notic:

U1A-D:LM324

Vdd:12V DC

Rs=47KΩ @ on an offset voltage

■ Spectral Response of Window Materials

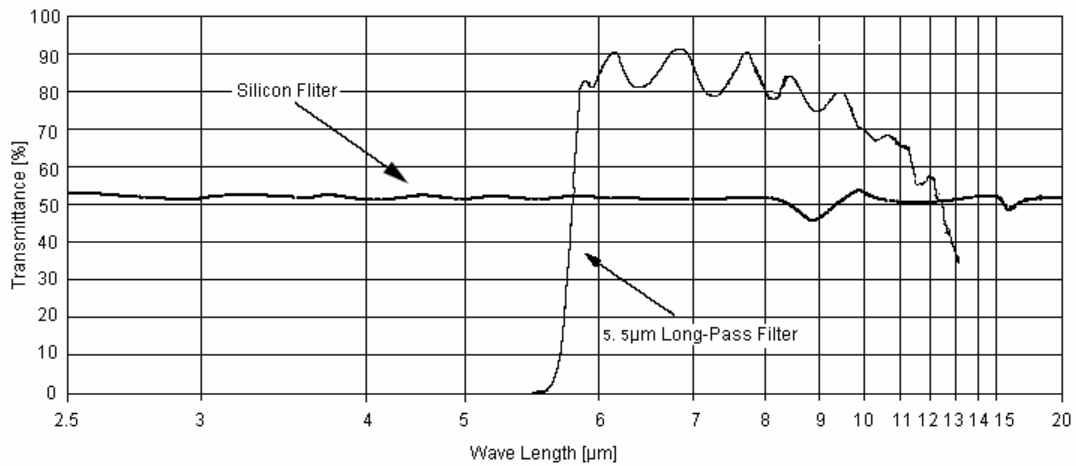

Notice:

5 μ m long-pass filter, which is the special vacuumed silicon filter, is the average IR penetrated curve line .

■ Fresnel Lens for Human Body Detection

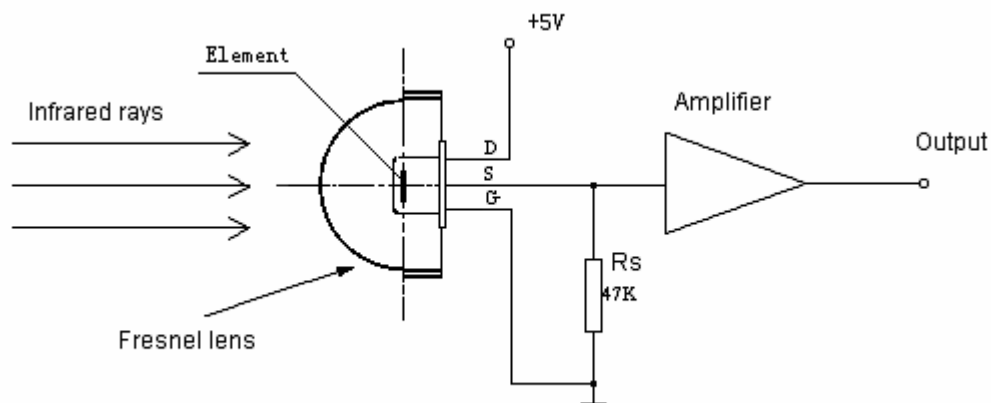
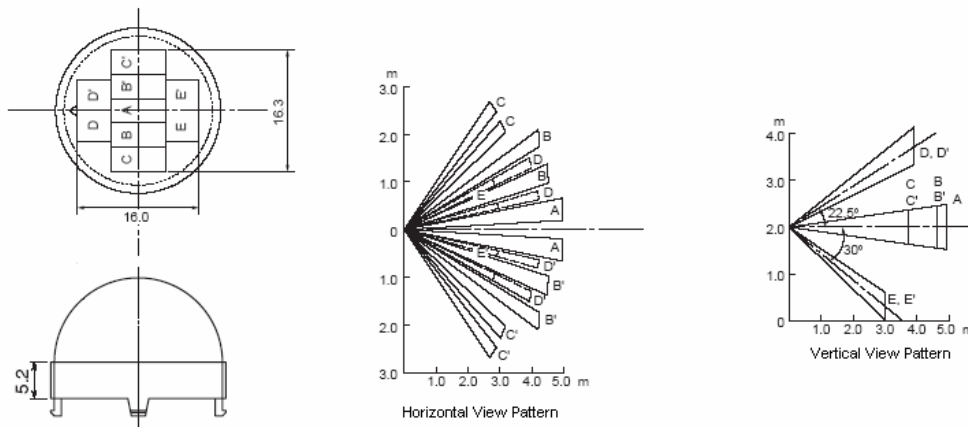

#### ■ Directions for Use

- Pay attention to the mounting direction of the sensor's element and the parts size in the ichnography, link with the focus of the Fresnel Lens, you can get a optimal optical design.
- The sensor parameter testing is operated in the condition of the standard Black Body and the interrelated circuit after one minute steadying-time.
- The sensor detect distance is a multidimensional function, which consist of ambient temperature, moving target temperature, Fresnel Lens' target distance, environment humidity, amplifier gain and comparison voltage.
- It is recommended that the welding length of the sensor's down-lead should not less than 4mm, and the welding time as short as possible.
- Do not touch the window by hand and the bard things.
- Strong shake and electrostatics should be avoided.
- This product packing adopt the environmental protection material, and the sensor's surface have been covered specially in the OHK anti-erode. Small packing for 100PCS; Big packing for 3000PCS.